

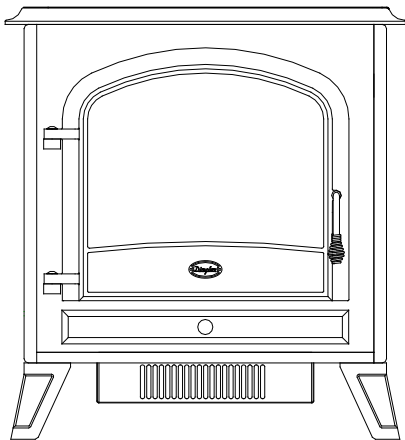

Better solutions through innovation



Owner's Manual

Model

SS5800PB

DS5804

DS5603

DS5804CM







IMPORTANT SAFETY INFORMATION: Always read this manual first before attempting to install or use this fireplace. For your safety, always comply with all warnings and safety instructions contained in this manual to prevent personal injury or property damage.

To view the full line of Dimplex products, please visit www.dimplex.com

7206570100R09



Table of Contents

 Welcome & Congratulations	3
 IMPORTANT INSTRUCTIONS	4
 Stove Installation	7
 Operation	8
 Maintenance	10
 Warranty	13
 Replacement Parts	16

Always use a qualified technician or service agency to repair this stove.

! NOTE: Procedures and techniques that are considered important enough to emphasize.

⚠ CAUTION: Procedures and techniques which, if not carefully followed, will result in damage to the equipment.

⚠ WARNING: Procedures and techniques which, if not carefully followed, will expose the user to the risk of fire, serious injury, or death.

Welcome & Congratulations

Thank you and congratulations for choosing to purchase an electric fireplace from Dimplex, the world leader in electric fireplaces.

Please carefully read and save these instructions.

⚠ CAUTION: Read all instructions and warnings carefully before starting installation. Failure to follow these instructions may result in a possible electric shock, fire hazard and will void the warranty.

Please record your model and serial numbers below for future reference: model and serial numbers can be found on the Model and Serial Number Label of your stove.

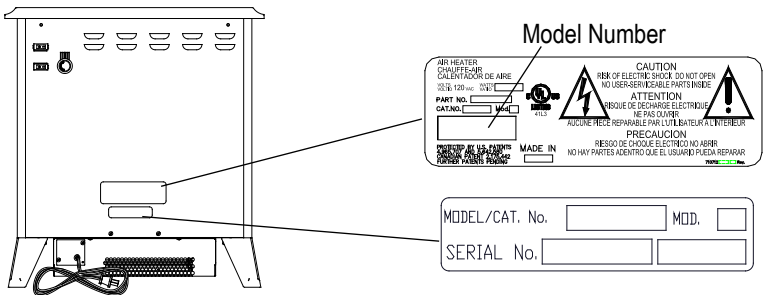

NO NEED TO RETURN TO THE STORE

Questions with operation or assembly? Require Parts Information?
Product Under Manufacturer's Warranty?

Contact us at:  www.dimplex.com/customer_support
For Troubleshooting and Technical Support

OR  **Toll-Free 1-888-DIMPLEX (1-888-346-7539)**
Monday to Friday 8:00 a.m. to 4:30 p.m. EST
Please have your model number and product serial number ready. (See above)



IMPORTANT INSTRUCTIONS

- ① Read all instructions before using the stove.
- ② The heater is hot when in use. To avoid burns, do not let bare skin touch hot surfaces. The trim around the heater outlet becomes hot during heater operation. Keep combustible materials, such as furniture, pillows, bedding, papers, clothes, and curtains at least three (3) feet (0.9 m) from the front of the unit.
⚠ CAUTION: High Temperature, keep electrical cords, drapery, and other furnishings at least 3FT (0.9m) from the front of the heater and away from the side and rear.
- ③ Extreme caution is necessary when any heater is used by or near children or invalids and whenever the unit is left operating and unattended.
- ④ Always unplug the stove when not in use.
- ⑤ Do not operate any unit with a damaged cord or plug, or if the heater has malfunctioned, or if the stove has been dropped or damaged in any manner. Return heater to authorized service facility for examination,
- electrical or mechanical adjustment, or repair.
- ⑥ Do not use outdoors.
- ⑦ The stove is not intended for use in bathrooms, laundry areas and similar indoor locations. Never locate heater where it may fall into a bathtub or other water container.
- ⑧ Do not run the cord under carpeting. Do not cover cord with throw rugs, runners, or the like. Arrange cord away from traffic area and where it will not be tripped over.
- ⑨ To disconnect the unit, turn the controls off, then remove the plug from the outlet.
- ⑩ Do not insert or allow foreign objects to enter any ventilation or exhaust opening as this may cause an electric shock or fire, or damage to the heater.
- ⑪ To prevent a possible fire, do not block air intake or exhaust in any manner. Do not use on soft surfaces, like a bed, where openings may become blocked.



CAUTION
RISK OF ELECTRIC SHOCK
DO NOT OPEN
NO USER-SERVICEABLE PARTS INSIDE





IMPORTANT INSTRUCTIONS

- ⑫ All electrical heaters have hot and arcing or sparking parts inside. Do not use in areas where gasoline, paint, or flammable liquids are used or stored or where the unit will be exposed to flammable vapors.
- ⑬ Do not modify the Stove. Use it only as described in this manual. Any other use not recommended by the manufacturer may cause fire, electric shock or injury to persons.
- ⑭ To reduce the risk of electric shock, this appliance has a polarized plug (one blade is wider than the other). This plug will fit in a polarized outlet only one way. If the plug does not fit fully in the outlet, reverse the plug. If it still does not fit, contact a qualified electrician to install the proper outlet. Do not change the plug in any way. This heater is not intended for use with an extension cord. Plug the cord directly into an appropriate wall receptacle.
- ⑮ Do not burn wood or other materials in the stove.
- ⑯ Do not strike the clear door panel.
- ⑰ Always use a certified electrician should new circuits or outlets be required.
- ⑱ Always use properly grounded, fused and polarized outlets.
- ⑲ Disconnect all power supply before performing any cleaning, maintenance or relocation of the unit.
- ⑳ When transporting or storing the unit and cord, keep in a dry place, free from excessive vibration and store so as to avoid damage.

SAVE THESE INSTRUCTIONS



IMPORTANT INSTRUCTIONS

! NOTE: This equipment has been tested and found to comply with the limits for Class B digital device, pursuant to part 15 of the FCC Rules. These limits are designed to provide reasonable protection against harmful interference in a residential installation. This equipment generates, uses and can radiate radio frequency energy and, if not installed and used in accordance with the instructions, may cause harmful interference to radio or television reception, which can be determined by turning the equipment off and on, the user is encouraged to try to correct the interference by one or more of the following measures:

- Reorient or relocate the receiving antenna.

- Increase the separation between the equipment and the receiver.
- Connect the equipment into an outlet on a circuit different from that to which the receiver is connected.
- Consult the dealer or an experienced radio/TV technician for help.

Operation is subject to the following two conditions: (1) this device may not cause interference and; (2) this device must accept any interference, including interference that may cause undesired operation of the device.



Stove Installation

! NOTE: A 15amp, 120 volt alternating current (VAC) circuit is required. A dedicated circuit is preferred but not essential in all cases. A dedicated circuit will be required if, after installation, the circuit breaker trips or fuse blows on a regular basis when the heater is operating. Additional appliances on the same circuit may exceed the current rating of the circuit breaker.

⚠ WARNING: Ensure the power cord is not installed so that it is pinched or against a sharp edge and ensure that the power cord is stored or secured to avoid tripping or snagging to reduce the risk of fire, electric shock or injury to persons.

⚠ WARNING: Construction and electrical outlet wiring must comply with local building codes and other applicable regulations to reduce the risk of fire, electric shock and injury to persons.

⚠ WARNING: Do not attempt to wire your own new outlets or circuits. To reduce the risk of fire, electric shock or injury to persons, always use a licensed electrician.

1. Make sure the units Main On/Off switch is switched Off (refer to operating instruction section).
2. Plug the unit directly into a 15 Amp/120 Volt outlet.

Operation

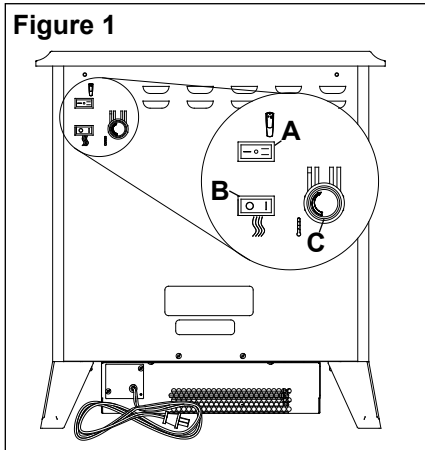

To access the controls go to the back of the Stove (Figure 1).

A. Three Position On/Off Switch

The switch has two On positions marked with “-” and “=” . The “-” position is for manual operation. In this position, the built-in remote control is bypassed.

The “=” position is for operating the unit with the provided remote control. When in “=” position the unit is operated with the ON and OFF buttons of the remote control.

When the switch is in the center position the unit is off.

B. Heater On/Off Switch

The Heater On/Off Switch supplies power to the heater fan and the heater element.

C. Heater Thermostat Control

To adjust the temperature to your individual requirements, turn the thermostat control clockwise all the way to turn on the heater. When the room reached the desired temperature, turn the thermostat knob counter clockwise until you hear a click. Leave in this position to maintain the room temperature at this setting. For additional heat, turn clockwise until you hear the click again and the heater will turn on. To turn the heater off, switch the Heater On/Off Switch to the Off position.

! NOTE: When the heater is switched On, the heater fan will operate. The heater element may or may not be on, depending on the thermostat control setting.

Operation

Resetting The Temperature Cutoff Switch

Should the heater overheat, an automatic cut out will turn the heater off and it will not come back on without being reset. It can be reset by switching the Main On/Off Switch to Off and waiting 5 minutes before switching the unit back on.

⚠ CAUTION: If you need to continuously reset the heater, unplug the unit and call Dimplex North America Limited at 1-888-346-7539.

Remote Control (Figure 2)

The stove is supplied with an integrated On/Off remote control, that is factory synchronized with the stove.

To operate, push the ON button to turn stove on, push the OFF button to turn the stove off. The amount of heat produced will be dependant on positioning of manual heat controls.

! NOTE: Ensure that the stove's On/Off switch is set to the remote control setting (" II " position).

Figure 2

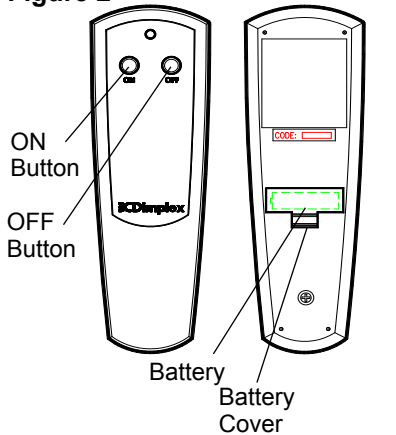

Initialization/Reprogramming

Follow these steps for remote control initialization if required:

- ① Set the main power switch to OFF.
- ② Set the 3 Position Switch to the Remote position (refer to Operation Section).
- ③ Wait a minimum of five (5) seconds and then turn the main power ON.
- ④ **Within 10 seconds** of re-acquiring power, press the ON button located on the remote control transmitter.

! NOTE: You will have only 10 seconds to perform this last

Operation

step. Failure to do so will result in these steps needing to be followed again.

This will synchronize the remote control transmitter and receiver.

Battery Replacement

- ① Slide battery cover open on the hand held transmitter (Figure 4).
- ② Correctly install one (1) 12 Volt (A23) battery in the battery holder.
- ③ Close the battery cover.

Maintenance

⚠ WARNING: Disconnect power before attempting any maintenance or cleaning to reduce the risk of fire, electric shock or damage to persons.

Light Bulb Replacement

⚠ CAUTION: Allow at least five (5) minutes for light bulbs to cool off before touching bulbs to avoid accidental burning of skin.

Light bulbs need to be replaced when you notice a dark section of the flame or when the clarity and detail of the log exterior disappears. There are two bulbs under the log set which generate the flames and embers.

Tool Requirements: Phillips screw driver

Helpful Hints

It is a good idea to replace all light bulbs at one time if they are close to the end of their rated life. Group replacement will reduce the number of times you need to open the unit to replace light bulbs.

Upper Light Bulb Requirements

Quantity of one (1) clear chandelier or candelabra bulbs with an E-12 (small) socket base, 7 Watt rating.

Upper Bulb Replacement

1. Open door by pulling the



Maintenance

handle.

2. Locate the upper bulb bracket. Bend light retainer bracket down. Locate and remove the light bulb. Insert new bulb.
3. Bend light retainer bracket back into its original position.
4. Close the door.

Lower Light Bulb Requirements

Quantity of two (2) clear chandelier or candelabra bulbs with an E-12 (small) socket base, 60 Watt rating.

Lower Bulb Replacement

1. Open door by pulling the handle. Remove the screw from the log set located in the center of the ember bed and remove the log set from the unit.
2. Locate and examine the bulbs to determine which bulb(s) required replacement.
3. Locate and remove the light bulb(s).
4. Insert new bulb(s).
5. Install the log set into the unit, pushing firmly against the glass. Replace the log set retaining screw into the

ember bed.

6. Close the door.

Glass Cleaning

The clear door is cleaned in the factory during the assembly operation. During shipment, installation, handling, etc., the clear door may collect dust particles, these can be removed by dusting lightly with a clean dry cloth.

To remove fingerprints or other marks, the clear door can be cleaned with a damp cloth. The clear door should be completely dried with a lint free cloth to prevent water spots. To prevent scratching, do not use abrasive cleaners or spray liquids on the clear door surface.

Plastic Door Cleaning

To remove fingerprints or other marks, the clear door can be cleaned with a damp cloth. The clear door should be completely dried with a lint free cloth to prevent water spots. To prevent scratching, do not use abrasive cleaners or spray liquids on the clear door surface.



Maintenance

Brass Door Cleaning

To remove fingerprints or other marks, the clear door can be cleaned with a damp cloth. The clear door should be completely dried with a lint free cloth to prevent water spots. To prevent scratching, do not use abrasive cleaners or spray liquids on the clear door surface.

Nickel Door Cleaning

To remove fingerprints or other marks, the clear door can be cleaned with a damp cloth. The clear door should be completely dried with a lint free cloth to

prevent water spots. To prevent scratching, do not use abrasive cleaners or spray liquids on the clear door surface.

Stove Surface Cleaning

Use warm water only to clean painted surfaces of the Compact Stove. Do not use abrasive cleaners.

Servicing

⚠ WARNING: Except for light bulb replacement and cleaning described above, an authorized service representative should perform any other servicing.



CAUTION
RISK OF ELECTRIC SHOCK
DO NOT OPEN
NO USER-SERVICEABLE PARTS INSIDE



Warranty

Products to which this limited warranty applies

This limited warranty applies to the following models of your newly purchased Dimplex electric stove **SS5800PB, DS5804, DS5603, DS5804CM** and to newly purchased Dimplex fireplace surrounds (mantels) and trims. This limited warranty applies only to purchases made in any province of Canada *except* for Yukon Territory, Nunavut, or Northwest Territories or in any of the 50 States of the USA (and the District of Columbia) *except* for Hawaii and Alaska. This limited warranty applies to the original purchaser of the product only and is not transferable.

Products excluded from this limited warranty

Light bulbs are not covered by this limited warranty and are the sole responsibility of the owner/purchaser. Products purchased in Yukon Territory, Nunavut, Northwest Territories, Hawaii, or Alaska are not covered by this limited warranty. Products purchased in these States, provinces, or territories are sold AS IS without warranty or condition of any kind (including, without limitation, any implied warranties or conditions of merchantability or fitness for a particular purpose) and the entire risk of as to the quality and performance of the products is with

the purchaser, and in the event of a defect the purchaser assumes the entire cost of all necessary servicing or repair.

What this limited warranty covers and for how long

Products covered by this limited warranty have been tested and inspected prior to shipment and, subject to the provisions of this warranty, Dimplex warrants such products to be free from defects in material and workmanship for a period of 12 months from the date of the first purchase of such product.

The limited 12 month warranty period also applies to any implied warranties that may exist under applicable law. Some jurisdictions do not allow limitations on how long an implied warranty lasts, so the above limitation may not apply to the purchaser.

What this limited warranty does not cover

This limited warranty does not apply to products that have been repaired (except by Dimplex or its authorized service representatives) or otherwise altered. This limited warranty does further not apply to defects resulting from misuse, abuse, accident, neglect, incorrect installation, improper maintenance or handling, or operation with an incorrect power source.



Warranty

What you must do to get service under this limited warranty

Defects must be brought to the attention of Dimplex Technical Service by contacting Dimplex at 1-888-DIMPLEX (1-888-346-7539), or 1367 Industrial Road, Cambridge Ontario, Canada N1R 7G8. Please have proof of purchase, catalogue/model and serial numbers available when calling. Limited warranty service requires a proof of purchase of the product.

What Dimplex will do in the event of a defect

In the event a product or part covered by this limited warranty is proven to be defective in material or workmanship during the 12 month limited warranty period you have the following rights:

- Dimplex will in its sole discretion either repair or replace such defective product or part without charge. If Dimplex is unable to repair or replace such product or part, or if repair or replacement is not commercially practicable or cannot be timely made, Dimplex may, in lieu of repair or replacement, choose to refund the purchase price for such product or part.
- Limited warranty service will be performed solely by dealers or service agents of Dimplex

authorized to provide limited warranty services.

- The purchaser is responsible for removal and transportation of such product or part (and any repaired or replacement product or part) to and from the authorized dealer's or service agent's place of business.
- This limited warranty does not entitle the purchaser to on-site or in-home services. On-site or in-home services may be performed at the purchaser's specific request and expense at Dimplex's then-current rates for such services.
- Dimplex will not be responsible for, and the limited warranty services shall not include, any expense incurred for installation or removal of the product or part (or any replacement product or part) or any labour or transportation costs. Such costs shall be the purchaser's responsibility.

What Dimplex and its dealers and service agents are also not responsible for:

IN NO EVENT WILL DIMPLEX, OR ITS DIRECTORS, OFFICERS, OR AGENTS, BE LIABLE TO THE PURCHASER OR ANY THIRD PARTY, WHETHER IN CONTRACT, IN TORT, OR ON



Warranty

ANY OTHER BASIS, FOR ANY INDIRECT, SPECIAL, PUNITIVE, EXEMPLARY, CONSEQUENTIAL, OR INCIDENTAL LOSS, COST, OR DAMAGE ARISING OUT OF OR IN CONNECTION WITH THE SALE, MAINTENANCE, USE, OR INABILITY TO USE THE PRODUCT, EVEN IF DIMPLEX OR ITS DIRECTORS, OFFICERS, OR AGENTS HAVE BEEN ADVISED OF THE POSSIBILITY OF SUCH LOSSES, COSTS OR DAMAGES, OR IF SUCH LOSSES, COSTS, OR DAMAGES ARE FORESEEABLE. IN NO EVENT WILL DIMPLEX, OR ITS OFFICERS, DIRECTORS, OR AGENTS BE LIABLE FOR ANY DIRECT LOSSES, COSTS, OR DAMAGES THAT EXCEED THE PURCHASE PRICE OF THE PRODUCT.

SOME JURISDICTIONS DO NOT ALLOW THE EXCLUSION OR LIMITATION OF INCIDENTAL OR CONSEQUENTIAL DAMAGES, SO THE ABOVE LIMITATION OR EXCLUSION MAY NOT APPLY TO THE PURCHASER.

How State and Provincial law apply

This limited warranty gives you specific legal rights, and you may also have other rights which vary from jurisdiction to jurisdiction. The provisions of the United Nations Convention on Contracts for the Sale of Goods shall not apply to this limited warranty or the sale of products covered by this limited warranty.



Replacement Parts

FLICKER MOTOR2000210100RP
(SS5800PB Flicker Motor)2000140100RP
HEATER ASSEMBLY2200490700RP
(SS5800PB Heater Assembly)2000230100RP
CAPACITOR2300030100RP
THERMOSTAT2300150100RP
3 POSITION ON/OFF/ON SWITCH2800071100RP
HEATER ON/OFF SWITCH2800070200RP
TERMINAL BLOCK4000070100RP
CORD SET4100040900RP
SINGLE LAMP HOLDER.4200121000RP
MIRROR5900060400RP
REFLECTOR ASSEMBLY.5900080500RP
CONTROL KNOB8800000300RP
REMOTE CONTROL.3000370500RP
REMOTE RECEIVER3000380200RP



Dimplex North America Limited

1367 Industrial Road
Cambridge ON
Canada N1R 7G8

© 2011 Dimplex North America Limited